

A modern living room scene featuring a 3D water fireplace. The fireplace is a long, low, rectangular unit with a dark, polished surface, containing a fire. It is set against a wall with a light-colored, textured stone or marble pattern. To the left, a potted plant with green leaves is visible. In the foreground, a grey sofa is partially visible. The overall lighting is dim, creating a cozy atmosphere.

3D WATER FIREPLACE

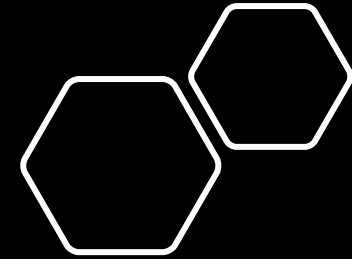

- No need for a chimney
- No carbon monoxide
- Non-flammable
- Environmentally friendly
- Flame is cold and is safe
- Choose from 7 different flame colors
- Manufacturer's 3 years warranty
- Safe for families with children and pets
- Easy to use: uses tap water to generate steam and operates with minimal electricity.



3D Steam Fireplaces - the best solution for any home or business where there is no chimney. It is especially suitable for families with young children, where there is a risk of children burning themselves with an open flame.

The **3D** steam fireplace creates a very impressive effect that resembles a real flame.

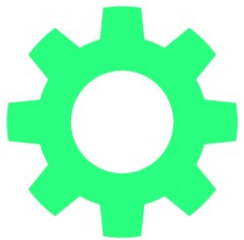

Easy to install



No ventilation required



Safe



Works with tap water

Natural and colored flames

Standard 7 colors change:

- Blue
- Green
- Red
- Orange
- Purple
- Light Blue
- Yellow



Model-WT72

Burner Specifications

- #304 stainless steel material
- Enable to connect with water tap directly
- Automatic filling function



Size	A (in)	B (in)	C (in)
WT72	72	7.6	6.6
Size	A (cm)	B (cm)	C (cm)
WT72	182.9	19.3	16.8

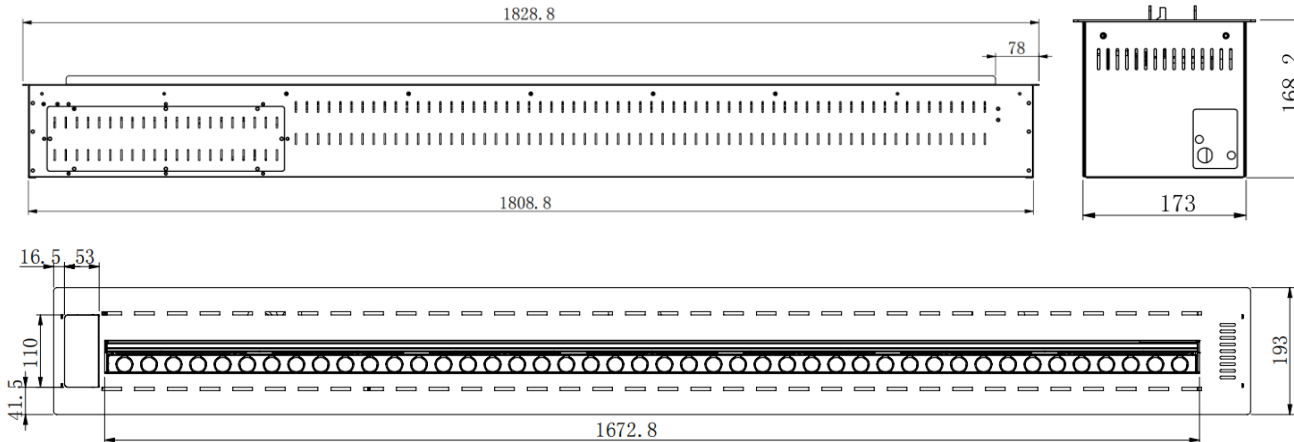

Standard Feature



- 7 Color Change
- 2.4G Wireless Remote control function

Optional Feature



- Control fireplace from APP
- Compatible with google /Alexa to make it voice enabled
- Integrate with smart home system (Lutron, Creston, KNX, etc)

Model-WT72

ALL YOU NEED IS WATER

The only fuel you need is water. Tap into the beauty of realistic flames in a totally unique fire. Use pure water vapor to simulate dancing flames with zero heat or fuels.

The tank and integrated pump allow for up to 50 hours of run time. Enjoy the glow of natural orange flames, choose from over 30 brilliant shades of colored flames.

UP TO 50 HOURS RUN TIME

Waterproof LED Strip Light

LED strips to use 50% less energy than traditional fluorescent, incandescent, and halogen lights. Full control over the color.

With automatic filling function, the fireplace will allow for a repeatable, reliable and consistent fill with each cycle based on volume. Quick and set your hand free

REFILLING SYSTEM

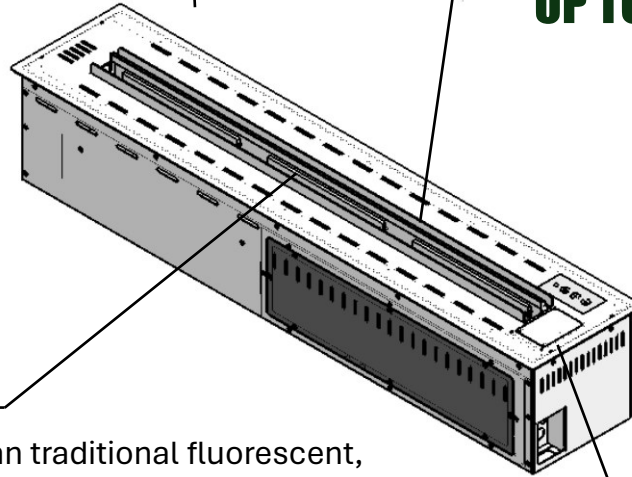
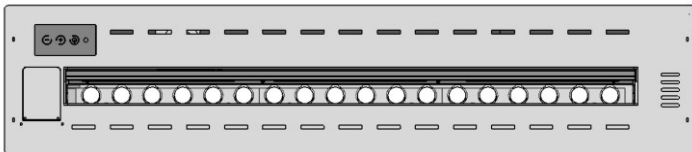

Model-WT72

Burner Specifications

Tank Capacity	10.8 liters	Electrical Connection	AC100-240v Current :1-6A
Run Time	28-37 hours	Working Frequency	50-60 Hz.
Weight	52Kgs 114.64 lbs	Flue	Not required
Application	For indoor use only	Flame Color	7 Colors – Waterplace

Cavity Measurements – Site-Built Enclosures

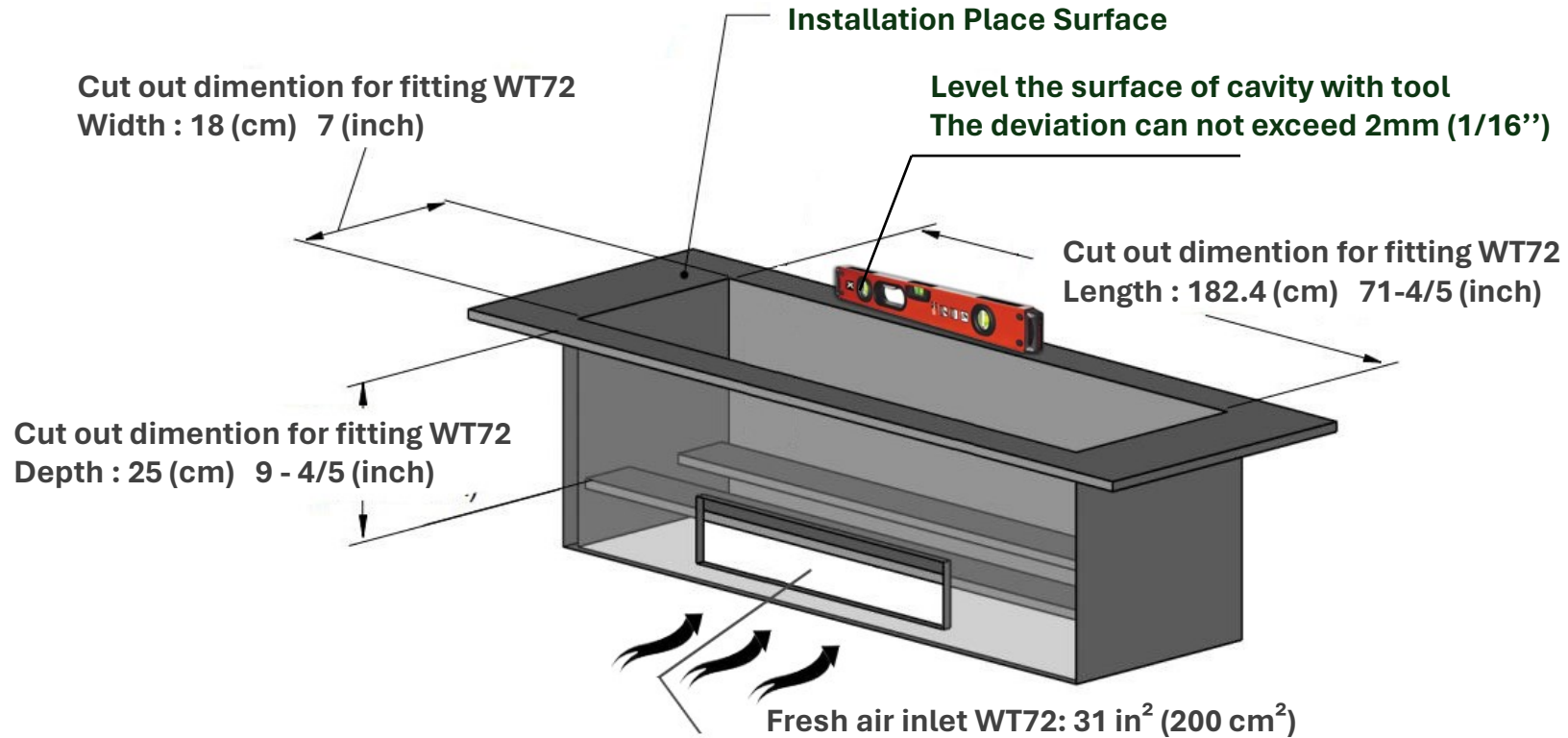

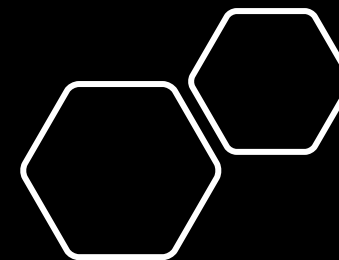

DISAINKAMINAD



DISAINKAMINAD



+372 56880012



info@disainkaminad.ee



www.disainkaminad.ee



Vana-Tartu mnt 79a, Peetri, Rae vald, 75312 Harju maakond