

BIOETHANOL FIREPLACE





AUTOMATIC

The automatic burner operates with 100% natural bioethanol and does not produce smoke or carbon monoxide. The burner has an automatic filling and spraying system.

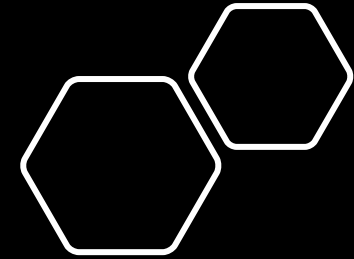

REMOTE CONTROL AND BEST QUALITY

The burner has 8 safety technologies and can be controlled via remote, phone, or a 'Smart Home' system.



Custom Measure



5+ Flame Setting



No Chimney



CE Certified



Technical Data: SR-18

	Material	SS304 Stainless steel
	Flame Size	339mm L
	Unit Dimension	457mm L x 193mm W x 168mm H
	Fuel Capacity	2 Liter
	Approx Burn Time	3.3-4 Hours
	Heat Out put Net	3947 W /13466 BTU
	Minimum Room	40-50 m ²
	Weight	G:12.5 Kgs; N:7.5 Kgs
	Application	For indoor use only
	Voltage	110-240V

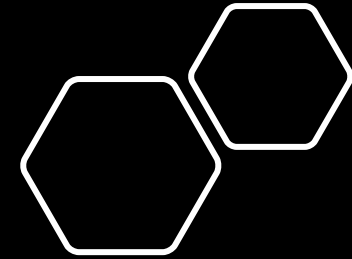
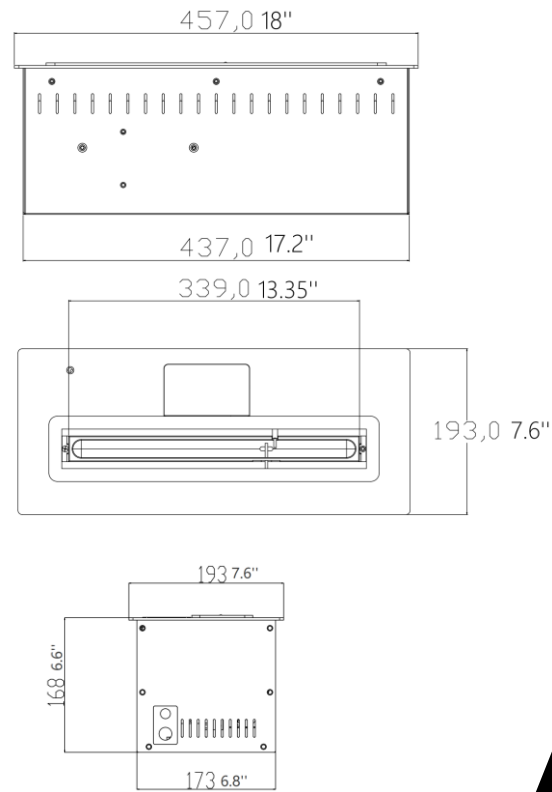



SAFETY INFORMATION 5×3

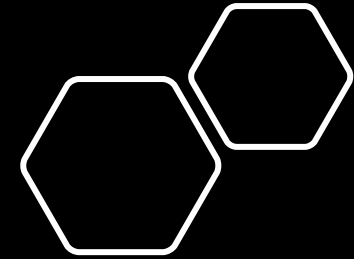
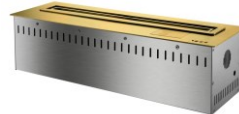
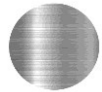
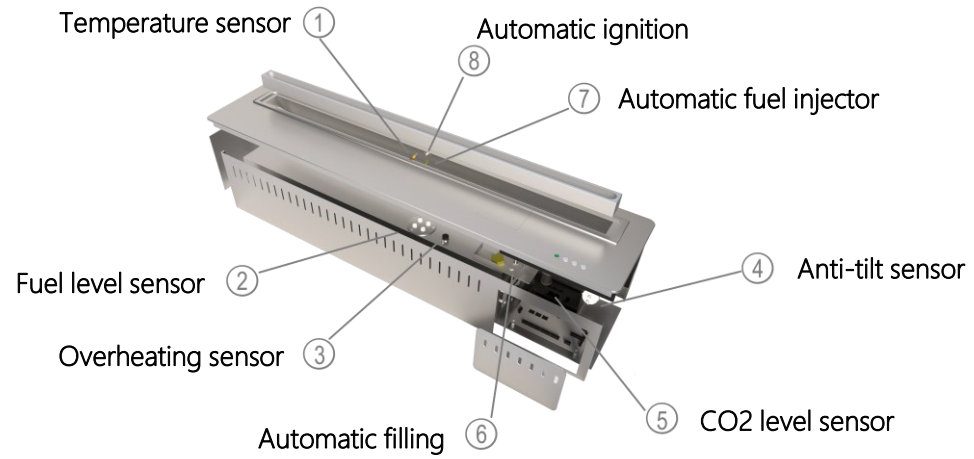

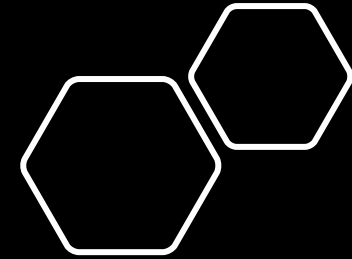

REMOTE CONTROL AND MANAGEMENT



Smart Home



Google Home



Amazon Echo Dot



Child lock

SMART HOME	RS-485	RS-232	DRY CONTACT
Z-WAVE	X		
CRESTON	X		
ZIGBEE	X		
BRITICINO	X		
M-BUS	X	X	
CONTROL-4		X	
RTI		X	X
MODBUS		X	
VIMAR BY-BY		X	
KNX			X
FABARO			X
LUTRON			X
TAPHOME			X

Specification & Clearance



Wall cavity of fire box

Fireplace Surrounds Need to be Non-combustible

	A	B	C
inch	15"	25-1/2"	17-3/4"
mm	383	647	450



Cut opening of enclosure

A standard 3-prong grounded 230-volt outlet is needed

	A	B	C
inch	7-1/5"	17-3/5"	9-4/5"
mm	183	447	250

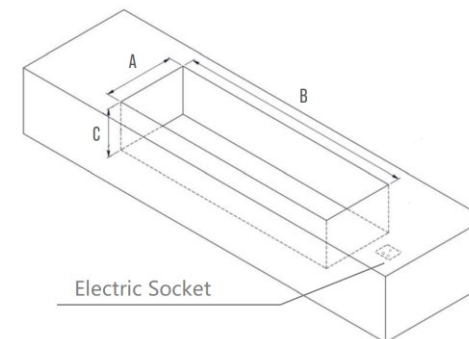

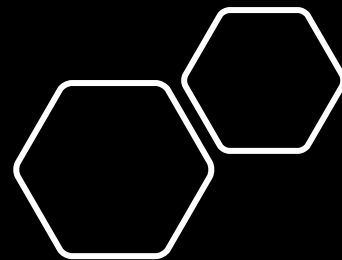

DISAINKAMINAD



DISAINKAMINAD



+372 56880012



info@disainkaminad.ee



www.disainkaminad.ee



Vana-Tartu mnt 79a, Peetri, Rae vald, 75312 Harju maakond