



# AURUKAMINAD

---

Tehniline brošüür

WT-seeria

Kõik mudelid • Tehnilised andmed  
Mõõdud • Paigaldusjuhised

- Ohutu
- Reaalne veeleek
- Nutijuhtimine



## Mudelite võrdlustabel

Materjal: roostevaba teras

Elektritoide: 230V / 50-60Hz

Viimistluse värv: Must/Harjatud hõbe

Veeühendus (valikuline): ½ väliskeere

Leegi tehnoloogia: LED+Veeaur

Kasutusala: Sisetingimustes

Mudel	Leegi laius	Toote mõõt	El.kulu (W/h)	Veepaak	Tööaeg
WT24	454 mm	610 x 193 x 168 mm	72 W/h	2 l	9-12h
WT30	606 mm	760 x 193 x 168 mm	108 W/h	3.25 l	9-13h
WT36	752 mm	910 x 193 x 168 mm	108 W/h	4 l	12-15h
WT48	1064 mm	1220 x 193 x 168 mm	215 W/h	6 l	13-17h
WT60	1368 mm	1520 x 193 x 168 mm	268 W/h	9 l	14-18h
WT72	1673 mm	1820 x 193 x 168 mm	305 W/h	10.8 l	14-18h
WT78	1844 mm	2000 x 193 x 168 mm	356 W/h	12 l	15-18h
WT250	2344 mm	2500 x 193 x 168 mm	450 W/h	13 l	14-19h

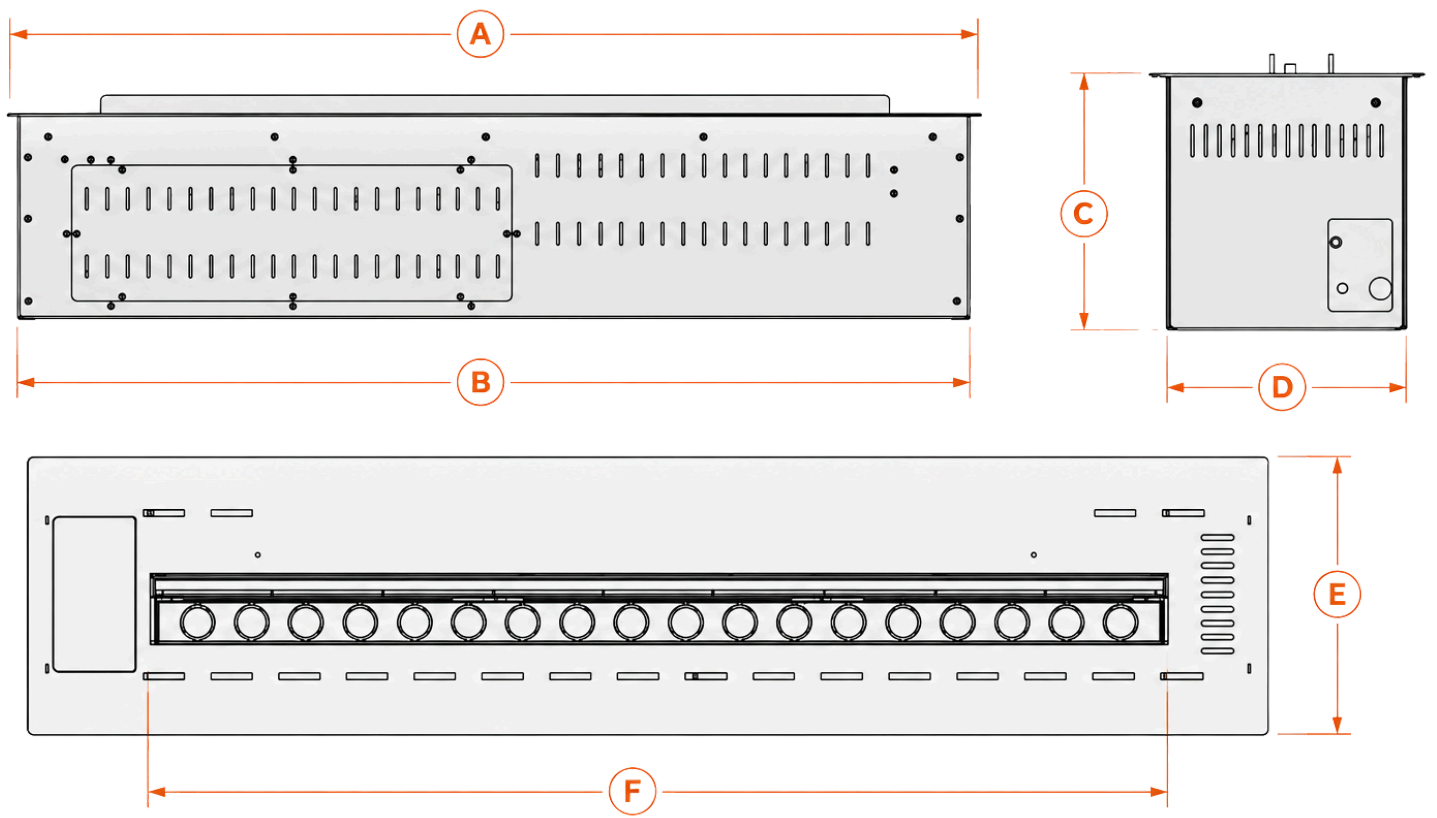

## Mõõtude joonis









Kõik mõõdud on (mm)



Mudel	A	B	C	D	E	F
WT24	610 mm	590 mm	168.2 mm	173 mm	193 mm	454 mm
WT30	760 mm	606 mm	168.2 mm	173 mm	193 mm	606 mm
WT36	910 mm	888 mm	168.2 mm	173 mm	193 mm	752 mm
WT48	1220 mm	1200 mm	168.2 mm	173 mm	193 mm	1064 mm
WT60	1520 mm	1504 mm	168.2 mm	173 mm	193 mm	1368 mm
WT72	1820 mm	1808.8 mm	168.2 mm	173 mm	193 mm	1673 mm
WT78	2000 mm	1980 mm	168.2 mm	173 mm	193 mm	1844 mm
WT250	2500 mm	2480 mm	168.2 mm	173 mm	193 mm	2344 mm



## OMADUSED JA FUNKTSIOONID

Loodud maksimaalse realismi ja lihtsa kasutuse jaoks.

-  RGB- erinevad värvitoonid
-  Aurutiheduse reguleerimine
-  Reguleeritav valgusrežiim
-  Leegi kõrguste valik
-  Lisab õhku kergelt niiskust
-  Automaatne veetäitmine
-  Automaatne tühjendamine
-  Võimalik ühendada veevõrku

-  WiFi / APP
-  Smart Home
-  Lapselukk

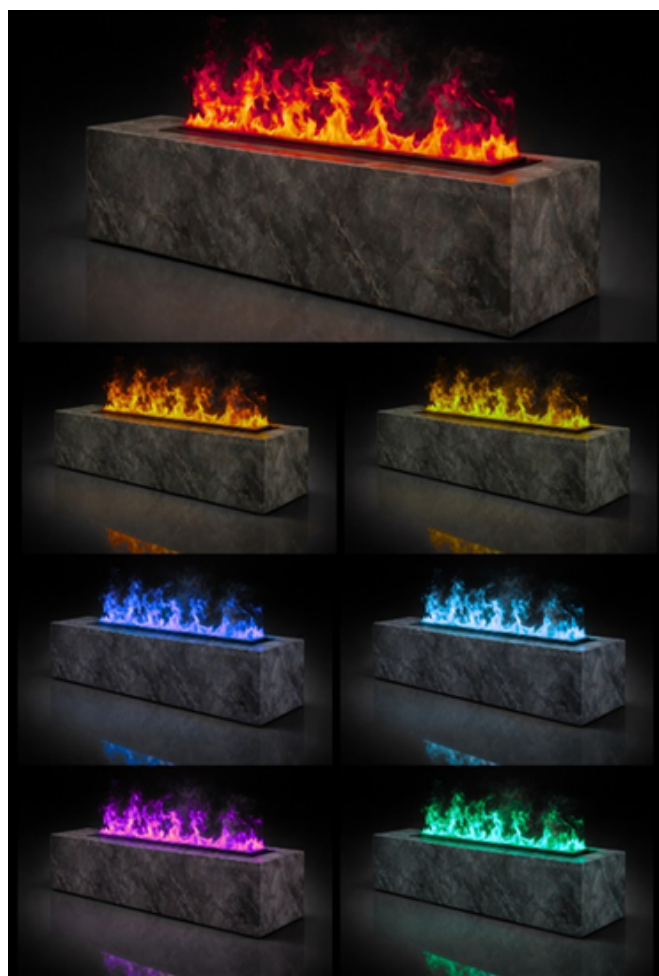



## PAIGALDUSJUHEND

Aurukamina paigaldus on kiire ja lihtne, kuna puudub vajadus korstna, suitsulõõri või gaasiühenduse järele. Seade vajab vaid elektriühendust ning soovi korral veeühendust. Korrektset rajatud kamina korpuse korral on paigaldus mugav ning hooldus lihtsasti ligipääsetav.

### Olulised paigaldussoovitused

🏗️ Välti suuri kamina korpuseid, mis võivad tekitada korstnaefekti.

⚡ Elektriühendus peab paiknema kamina korpuses all paremal.

💧 Veeühendus (soovi korral) peab paiknema kamina korpuses all vasakul.  
**NB!!** Vee sulgkraan peab olema teenindatavas kohas.

👉 Tagada kamina korpusesse vähemalt 200 cm<sup>2</sup> õhuava.

🔧 Kamin tuleb paigaldada nii, et seadet oleks võimalik vajadusel lihtsalt eemaldada ja hooldada.

🎨 Mida tumedam on kamina sisepind, seda realistlikum ja sügavam on auruleegi efekt.. **NB!** Seina sisse paigaldatava kamina sisemine osa peab olema tumedat värvi (soovitavalt matt must).

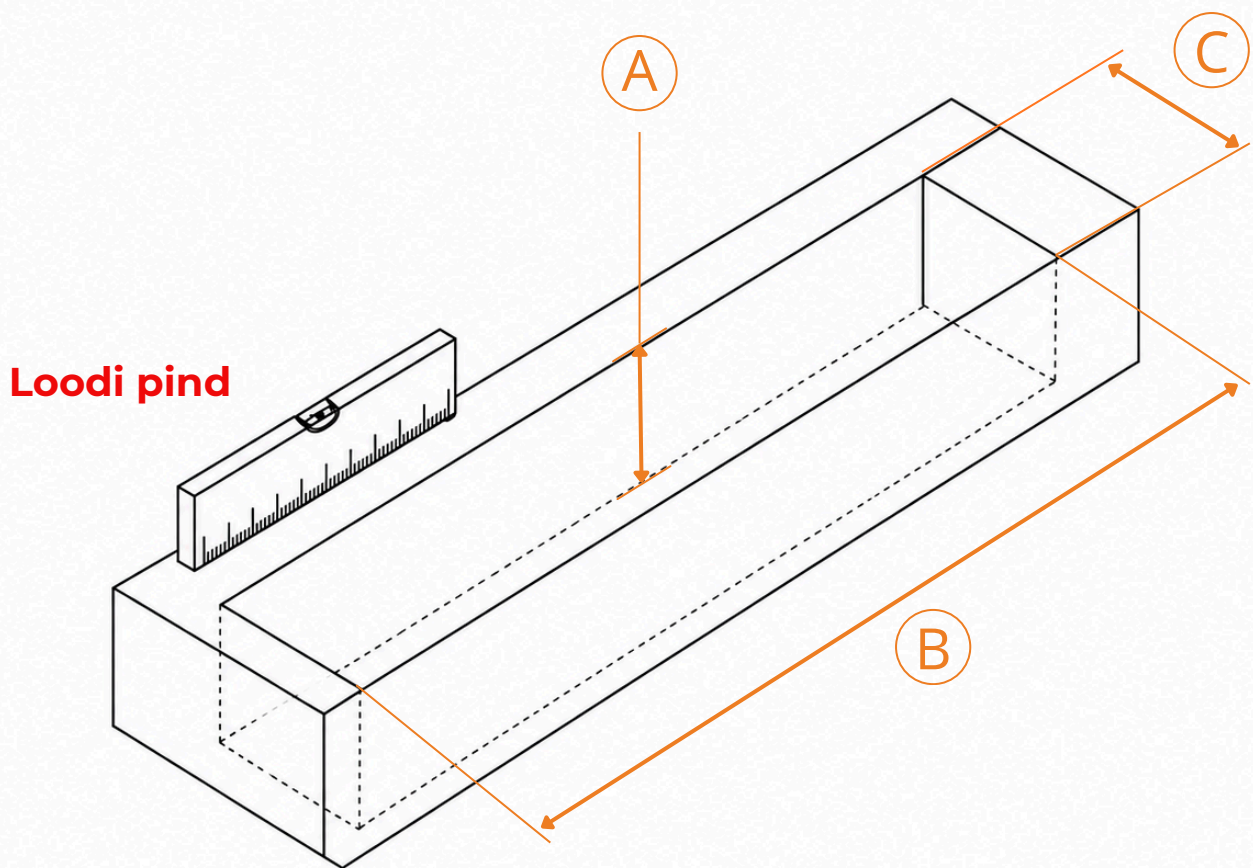

## PAIGALDUSAVA MÕÕDUD

Paigaldusava mõõdud sisaldavad vajalikku paigaldusvaru. Suuremat ava teha ei ole soovitatav.

Mudel	A (min)	B	C
WT24	250 mm	600 mm	180 mm
WT30	250 mm	752 mm	180 mm
WT36	250 mm	898 mm	180 mm
WT48	250 mm	1210 mm	180 mm
WT60	250 mm	1514 mm	180 mm
WT72	250 mm	1819 mm	180 mm
WT78	250 mm	1990 mm	180 mm
WT250	250 mm	2490 mm	180 mm

# PAIGALDUSKAUGUSED JA VÕIMALUSED

NB! Joonistel toodud mõõdud on minimaalsed nõutavad paigalduskaugused kamina külgedelt ja kamina kohale. Neid vahekaugusi ei tohi vähendada.

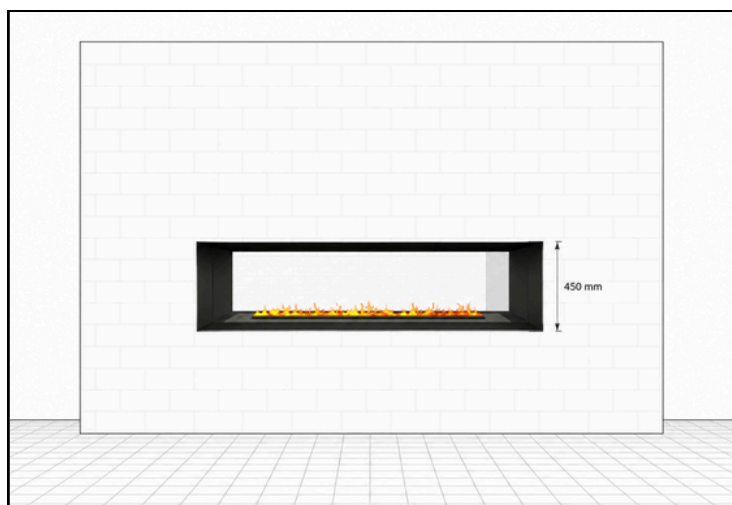
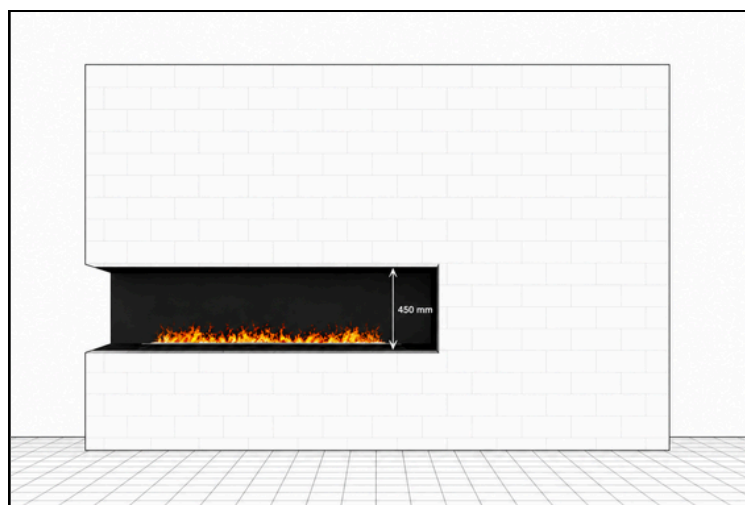
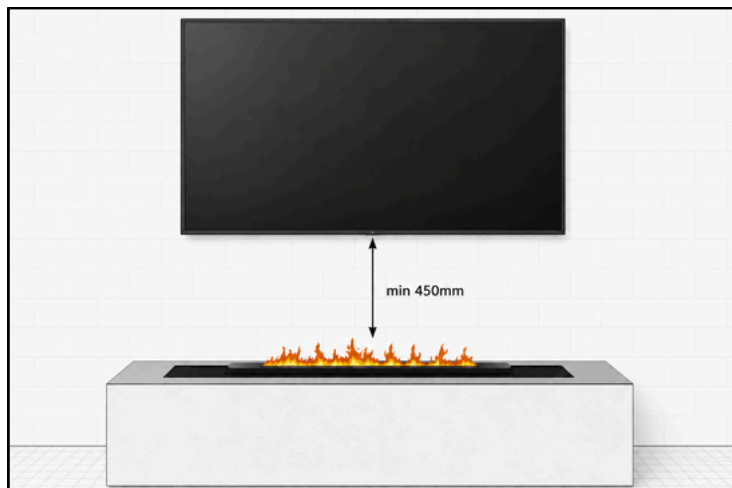
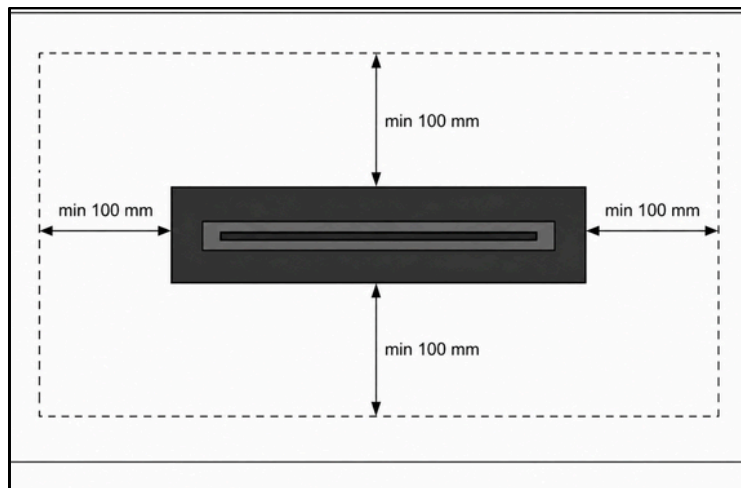

# Meelerahu algab leegist, mida ei pea kartma.

Realistlik leek.  
Moderne disain.  
Lihtne paigaldus.



DISAINKAMINAD



Vana-Tartu mnt 79, Peetri,  
Rae vald



+372 5688 0012



info@disainkaminad.ee



www.disainkaminad.ee

Tutvu kogu  
tootevalikuga

